

Article number: 03554025

Description: Fluro hydraulic rod end FMA 25D

## Measures

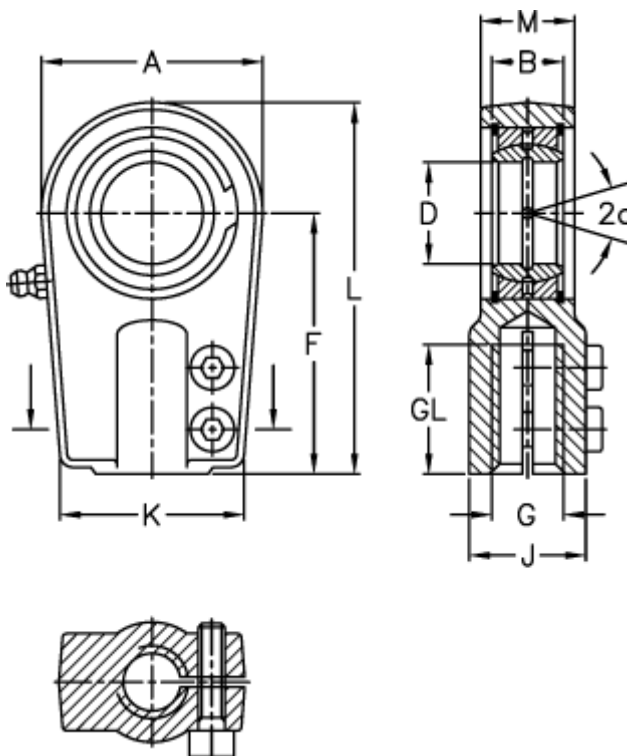

A	= 56	J	= 28
a (degrees)	= 8	K	= 48
B	= 20	L	= 95
D	= 25	M	= 23
Dynamic load C (kN)	= 51	Static load C0 (kN)	= 66
F	= 65	Torque (N m)	= 20
g	= M18x2	Weight	= 650
GL	= 30		